

478

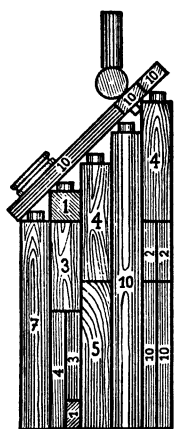

458/2

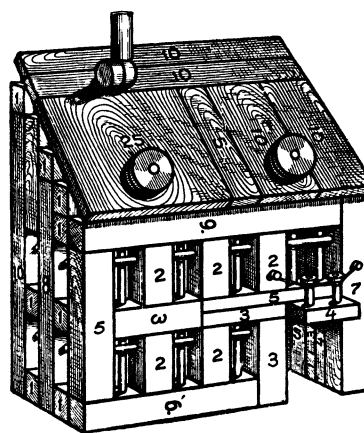

458

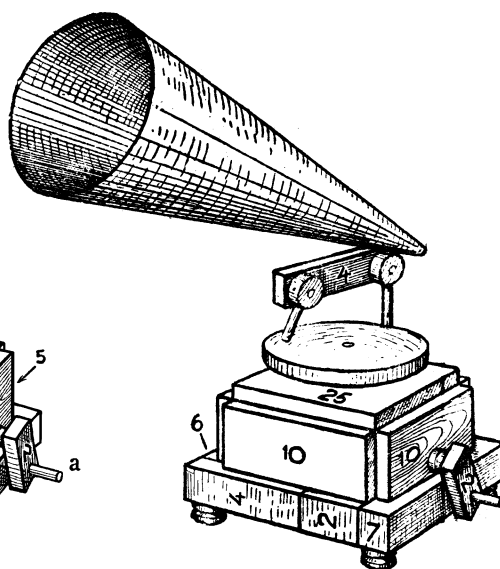

419

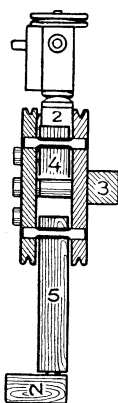

478/3

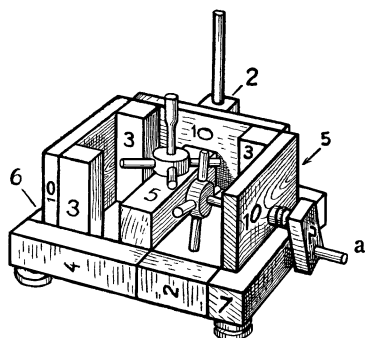

419/2

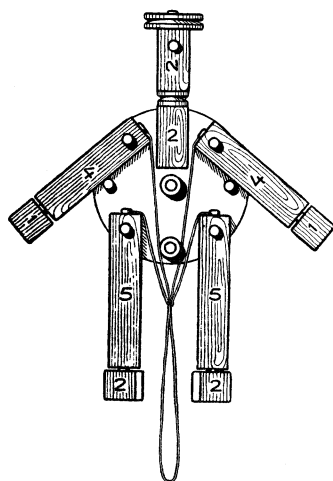

478/2

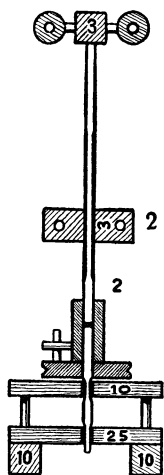

420/2

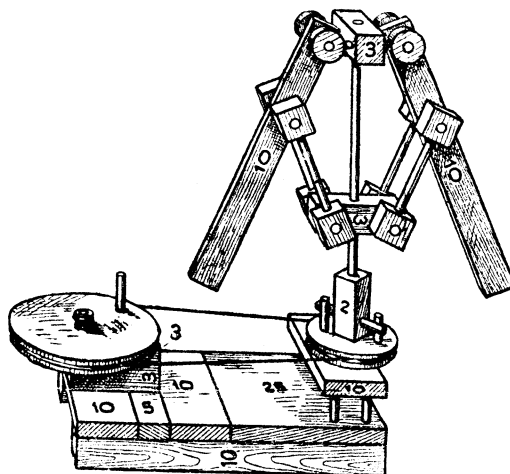

420